



## DATOS MOTOR

POTENCIA	3HP
REVOLUCIONES	1760
FRECUENCIA	60HZ
TORQUE MOTOR NOMINAL	12,2
CARCASA (PAM)	90(B5)
TIPO BRIDA	FF-165
EFICIENCIA MOTOR	IE 2

## DATOS REDUCTOR

REFERENCIA	550008
TIPO	ORTOGONAL
MODELO	FCN
MATERIAL	ALUMINIO
CARCASA	90
RELACION DE TRANSMISION i:	50
VELOCIDAD SALIDA	35,20
TORQUE MAXIMO	340
TORQUE OPERACIÓN	439
FACTOR DE SERVICIO	0,8

## PLANOS REDUCTOR

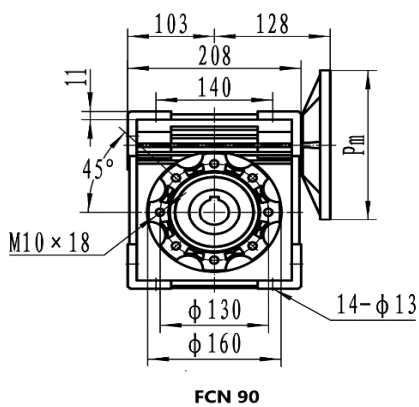

Input shaft hole

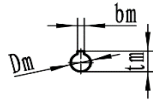

Output shaft hole

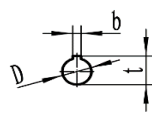

Dimensions of Output Shaft			
D H7	b D10	t	
35	10	38.3	

	Pm	Dm	bm	tm
80B5	200	19	6	21.8
80B14	120			
90B5	200	24	8	27.3
90B14	140			
100/112B5	250	28	8	31.3
100/112B14	160			

